



OPERATING KEY

VARIO

VARIO

Operating Key

versatile • ergonomic • compact



VARIO

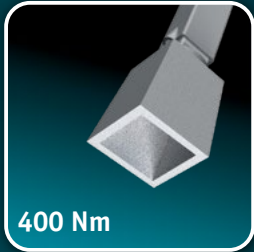

400 Nm

SUPER VARIO

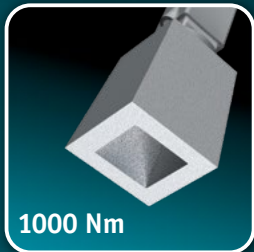

1000 Nm

VARIO STEPLESS



VARIO LED

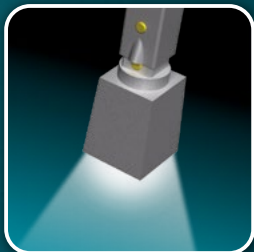

Content

4 **VARIO Operating Key**

4 **VARIO stepless**

5 **SUPER-VARIO**

5 **VARIO-LED**

VARIO range of products:

6 Basic Configuration

6 Operation Insets

7 Single Components

9 **Adjustable Steps**

10 Quality and service

11 Advice and sales

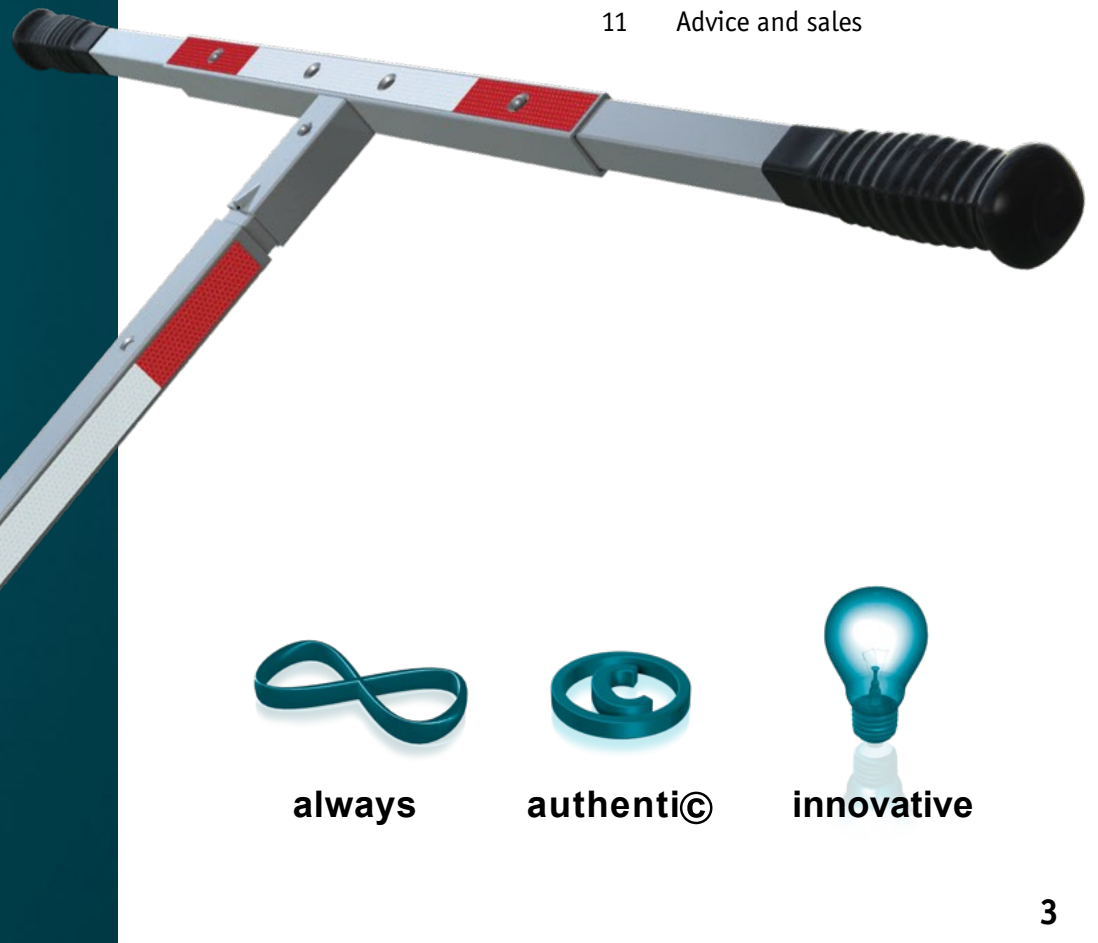

always



authenti©



innovative

VARIO-Operating Key



Versatile

VARIO Operating Key is a special tool to actuate valves and hydrants above and below the ground, as well as in manholes. By using a wide range of operation insets VARIO Key can be used to operate valves as well as hand-wheels. Insets can be changed quickly and conveniently by pressing integrated spring connection pieces. By adding a ratchet, cross joint or other modifications, VARIO is even more versatile. While exclusively using stainless steel pipe-in-pipe construction and can transmit up to 400 Nm of torque.

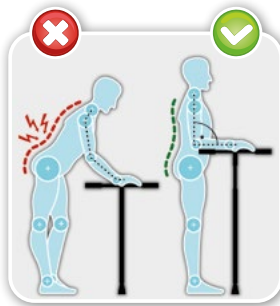

Ergonomic

VARIO Operating Key is ergonomically designed. By being easily adjustable in height, the operator is able to stand in an upright position. This posture sparing his back and spine from a hunched position that may lead to physical injuries. Furthermore, both sides of the T-handle can be extended to generate additional torque.

Compact

VARIO Operating Key can be disassembled and transported easily, compactly and safely using the transport bag provided. Pipe-in-pipe construction also reduces the weight of the VARIO Key significantly, making handling and transport even more convenient.



NEW VARIO STEPLESS

Our new **VARIO stepless** now makes it even easier to adopt an upright posture. The stepless height adjustment, in the range from 1000 to 1560 mm, allows you to adjust the operating key to the perfect ergonomic position in almost all situations.



- 1 T-handle
VA
- 2 Telescopic rod
VA
- 3 Operating socket "small"
for service valves
VA/Temperguss
- 4 Operating socket "large"
for gate valves
VA/Temperguss
- 5 Surface-box hammer
- 6 Transport bag
PES

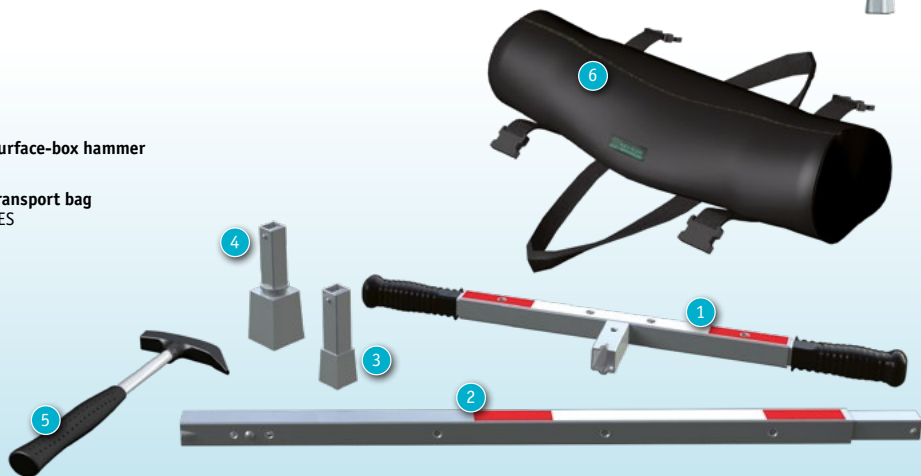

SUPER VARIO

The **SUPER-VARIO** can be loaded with a torque of up to 1000 Nm thanks to the reinforcement of the basic components, such as the T-handle, telescopic rod and the operating socket "large" for gate valves. All special components are also available for the SUPER-VARIO, but can only be loaded up to 400 Nm due to their design or application.



1000 Nm

VARIO LED

The **VARIO-LED** has the option of illuminating the operating socket especially for night-time use or in dark places. This ensures accurate and precise positioning of the operating spanner on the spindle square. The lighting can be switched on or off in three simple steps.

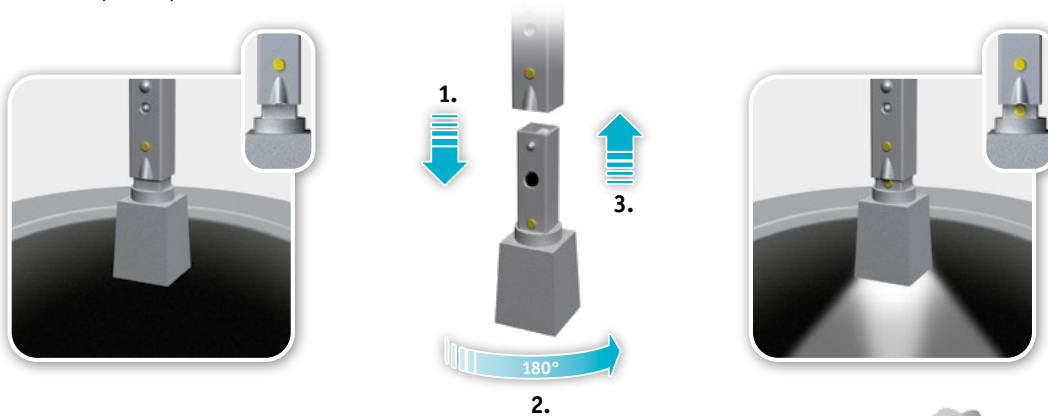

Inductive charging and LED technology enable permanent and problem-free use in wet and dirty areas.



VARIO-Operation Insets

- 1 Double-sided ratchet
CrV
- 2 Ratchet adaptor
VA
- 3 Operating socket "small"
for service valves
VA/Temperguss
- 4 Operating socket "large"
for gate valves
VA/Temperguss
- 5 Cross joint
VA
- 6 Operating socket "small"
Three-Edged-Wedge
VA
- 7 Operating socket "large"
Three-Edged-Wedge
VA
- 8 Operating socket "hexagonal"
VA

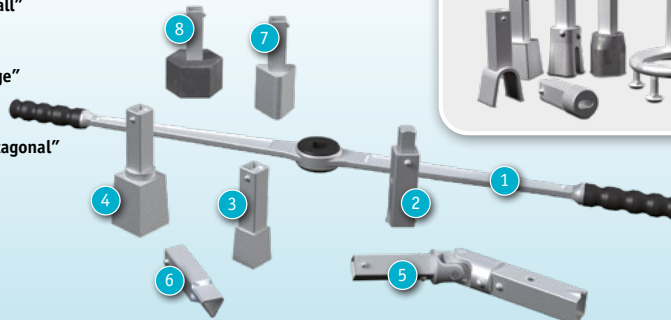

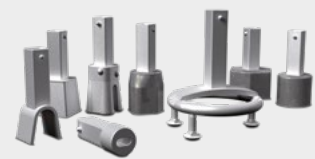

Additional shapes on request



VARIO-Basic Configuration

VARIO Operating Key can be disassembled and transported easily, compactly and safely using the transport bag provided. Pipe-in-pipe construction also reduces the weight of the VARIO Key significantly, making handling and transport even more convenient.



	VARIO < 400 Nm	VARIO STEPLESS < 400 Nm	SUPER VARIO < 1000 Nm
Standard Set 1 x Telescopic rod 1 x T-handle 1 x Operating socket "small" ¹⁾ * 1 x Operating socket "large" ²⁾ 1 x Surface-box hammer 1 x Transport bag	Sales No. BTV 00 025 Weight 7.50 kg	Sales No. BTV 00 094 Weight 7.50 kg	Sales No. BTV 00 063 Weight 10.00 kg <small>*without operating socket "small"¹⁾</small>
Standard Set 1 x Telescopic rod 1 x T-handle 1 x Operating socket "small" ¹⁾ 1 x Operating socket "large" ²⁾ 1 x Surface-box hammer 1 x Transport bag 1 x Charger (230V) 1 x Vehicle-Adaptor (12V)	Sales No. BTV 00 053 Weight 8.00 kg	 Not possible with VARIO stepless.	 Not possible with Super-VARIO.

¹⁾ "small" = Operating socket for service valves
²⁾ "large" = Operating socket for gate valves

VARIO-Operation Insets

Each operating inset is equipped with a pressure piece and can be changed in a few simple steps. A special reduction adapter makes it possible to use all control insets for the SUPER-VARIO as well. However, the LED function is excluded for the SUPER-VARIO.

VARIO □ 25 mm < 400 Nm	VARIO LED □ 25 mm < 400 Nm
 Operating socket "small" for service valves DIN 2332 Type 12 - 14 mm Sales No. EME 00 135 Weight 0.30 kg	 Operating socket "small" for service valves DIN 2332 Type 12 - 14 mm Sales No. EME 00 397 Weight 0.30 kg
 Operating socket "large" for gate valves DIN 2332 Type 27 - 32 mm Sales No. EME 00 136 Weight 0.90 kg	 Operating socket "large" for gate valves DIN 2332 Type 27 - 32 mm Sales No. EME 00 398 Weight 0.90 kg
 Operating socket "small" Three-Edged-Wedge DIN 2332 Type Sales No. EME 00 137 Weight 0.25 kg	
 Operating socket "large" Three-Edged-Wedge DIN 2332 Type Sales No. EME 00 138 Weight 0.40 kg	 Operating socket "large" for gate valves DIN 2332 Type 27 - 32 mm Sales No. EME 00 448 Weight 1.44 kg
 Operating socket "hexagonal" DIN 2332 Type Sales No. EME 00 139 Weight 0.80 kg	 SUPER VARIO □ 30 mm < 1000 Nm Reduction adapter < 400 Nm 30 - 25 mm Sales No. EME 00 451 Weight 0.55 kg 

VARIO-Single Components

The individual components extend the application possibilities of the VARIO Operating Key or enable certain functions to be retro-fitted. A detailed specification of the materials or properties of the individual VARIO components can be found at: www.kettlerweb.de/en/ → Product → VARIO



		VARIO	SUPER VARIO
Telescopic rod	Sales No. Weight	EME 00 245 2.50 kg	EME 00 446 3.08 kg
Telescopic rod STEPLESS	Sales No. Weight	EME 00 625 2.50 kg	- -
Telescopic rod LED	Sales No. Weight	EME 00 263 2.50 kg	- -
T-handle	Sales No. Weight	BTV 00 013 1.90 kg	EME 00 445 3.39 kg
Cross joint	Sales No. Weight	EME 00 145 2.20 kg	EME 00 447 2.17 kg
Double-sided Ratchet incl. adapter	Sales No. Weight	EME 00 230 3.40 kg	- -
Ratchet incl. adapter	Sales No. Weight	EME 00 144 2.00 kg	- -
Charger (230 V)	Sales No. Weight	EME 00 405 0.50 kg	- -
Vehicle-Adaptor (12 V)	Sales No. Weight	EME 00 404 0.50 kg	- -
Surface-box hammer	Sales No. Weight	EME 00 133 1.00 kg	- -
Transport bag	Sales No. Weight	BTV 00 010 1.10 kg	- -



VARIO-Adjustable Steps

VARIO Operating Key is ergonomically designed. By being easily adjustable in height, the operator is able to stand in an upright position. This posture sparing his back and spine from a hunched position that may lead to physical injuries. Furthermore, both sides of the T-handle can be extended to generate additional torque.

VARIO STEPLESS

900 mm | 690 mm

1560 mm
↕
1000 mm

NEW

A small twist for optimum height.

Our latest addition to the proven VARIO range now makes it even easier for you to adopt an upright posture. The stepless height adjustment, in the range from 1000 to 1560 mm, allows you to adjust the operating key perfectly in almost all situations - your back will certainly thank you.

Model	Width (mm)	Height (mm)
VARIO STEPLESS	900	1560
VARIO STEPLESS	690	1360
VARIO STEPLESS	690	1160
VARIO STEPLESS	690	960
SUPER VARIO	1220	1575
SUPER VARIO	1220	1380
SUPER VARIO	1220	1185
SUPER VARIO	880	990

VARIO and torcbrain the perfect combination

The KETTLER-torcbrain is your perfect companion if you come across 'stubborn' valves and hydrants again and need support. The mobile cordless high torque wrench fulfils all requirements for inspectionwork in communal or industrial pipe networks.

It doesn't matter whether you need to operate valves and hydrants in underground areas or valves with handwheels. The KETTLER-torcbrain is the perfect addition to the VARIO Operation Key and offers you powerful support from 400 Nm - 950 Nm.

The KETTLER-torcbrain makes daily work easier thanks to its mobility, precision and reliability.



Always. Authentic. Innovative.

We at KETTLER GmbH have been living this **mission statement** for over 40 years. By consistently focusing on this, we have been able to develop into one of the leading companies in underground pipeline construction.

Time and again, we have been able to set milestones with **innovative KETTLER brand** products, particularly when it comes to the operation of Valves and fittings

As a central structure in the gas and water supply, the piping system is extremely important and maintenance and servicing are particularly important. Ultimately, the **quality** of the products used determines the **reliability** and **safety** of the pipe network.

KETTLER has always stood for this **reliability** with the highest **quality** standards - both in our products and in all business processes with **sincere** and **binding** communication with customers and suppliers.

With the **KETTLER brand**, you can rely on **safety** and **continuous development** for the **future**.

Now you know what's behind these symbols - see for yourself!



always



authenti©



innovative

Advice and sales

If your request concerns articles, prices, offers, orders or delivery times, you can contact our office staff directly. If you need technical advice over the phone or would like to arrange a personal appointment, please contact our sales representatives.

As an international customer, our export team will be happy to provide you with advice and assistance.

Simply get in touch with us ...



Head office

Phone: +49(0)2369 9182-0
Fax: +49(0)2369 9182-91
info@kettlerweb.de
www.kettlerweb.de

Back office

Phone: +49(0)2369 9182-21
Phone: +49(0)2369 9182-41
Fax: +49(0)2369 9182-91
info@kettlerweb.de

Sales force

Phone: +49(0)2369 9182-33
Fax: +49(0)2369 9182-91
info@kettlerweb.de

Export

Phone: +49(0)2369 9182-25
Fax: +49(0)2369 9182-91
info@kettlerweb.de

IVENS GmbH

Industrial representatives

Michael Weißenrieder
Mobile: +49(0)175 5419189
Jürgen Ivens
Mobile: +49(0)171 8557367
info@ivens-gmbh.de



Special Services

Phone: +49(0)2369 9182-22
Fax: +49(0)2369 9182 91
info@kettler-kuc.de
www.kettler-kuc.de





always – authenti© – innovative

KETTLER GmbH
Köhlerstraße 8
46286 Dorsten-Wulfen
Germany
Phone +49(0)2369 9182-0
Fax +49(0)2369 9182-91
info@kettlerweb.de
www.kettlerweb.de